



Assembly and Operating Guide

POWER CHAIN SAW HOLDER

Type P2

**CAUTION! THIS HOLDER IS NOT SUITABLE TO
BE WORN ON THE HUMAN BODY - DANGER
TO LIFE AND LIMB!**



List of Contents

1	FOREWORD	4
1.1	MARKING	4
1.2	LEGAL NOTICE	4
1.3	LIABILITY	5
2	INTENDED USE	6
2.1	INSTALLATION OPTIONS	7
2.2	TARGET GROUP AND PRIOR KNOWLEDGE	7
2.3	CONTENT AND PURPOSE OF THIS DOCUMENTATION	8
2.4	LIMITS OF USE	8
2.5	PERIOD OF USE	8
3	SAFETY OF THE POWER CHAIN SAW HOLDER	9
3.1	SIGNAL WORDS USED IN SAFETY NOTICES	9
3.2	SYMBOLS USED IN SAFETY NOTICES	10
3.3	RESIDUAL HAZARDS	11
3.4	SAFETY NOTICES FOR THE OPERATOR	16
3.5	PERSONAL PROTECTIVE EQUIPMENT	16
3.6	SAFETY NOTICES ON THE POWER CHAIN SAW HOLDER	17
3.7	GENERAL SAFETY REGULATIONS AND DUTIES	17
4	TYPE OVERVIEW	18
4.1	TYPE PLATE	18
5	SCOPE OF DELIVERY	19
6	INSTALLATION/PLACE OF ASSEMBLY	20
7	DETAILED NOTICE ON MOUNTING AND USE	22
8	MOUNTING OPTIONS	23
9	INITIAL COMMISSIONING	24
10	GENERAL SPECIFICATION	24
10.1	STRUCTURE	24
10.2	OPERATION	25
11	SERVICING AND MAINTENANCE ACTIVITIES	26
11.1	CLEANING THE POWER CHAIN SAW HOLDER	26
11.2	MAINTENANCE	26
11.3	REPAIR	27

12	REPLACEMENT AND WEARING PARTS	27
13	SHUTTING DOWN THE POWER CHAIN SAW HOLDER	27
13.1	PRINCIPLE	27
13.2	MATERIALS AND PARTS FOR THE POWER CHAIN SAW HOLDER	28
14	APPENDIX	29
14.1	EC DECLARATION OF CONFORMITY	29

Versions

Version	Date	Chapter	Specification
0.1	09.02.2016		Draft of docu solutions
0.2	18.02.2016		Expanded version
0.3	25.02.2016		Status User Evaluation Information Event
0.4	12.04.2016		SW
0.5	13.04.2016		Correction of docu solutions
0.6	18.04.2016		SW
0.7	24.11.2016		Supplement to type plate, added corr. term 'power chain saw'
0.8	08.08.2017		Supplement "Not to be worn on the body"

Important notice: Ensure that you have a copy of the latest version in force of this Assembly and Operating Guide. You can find this at any time in the download area of our website, www.toolprotect.at.

Copyright®

This original documentation is protected by copyright. All rights, in particular the rights to reproduction, dissemination and translation reserved. No part of this guide may be reproduced in any form whatsoever (photocopy, micro-film or any other process) or stored, processed, reproduced or disseminated in any electronic system without the written authorisation of CEPAK GmbH. Breaches of copyright may incur penalties under criminal law.

© 2016 Company CEPAK GmbH

® Ing. Christoph Cepak is the sole proprietor and personal authorised holder of the listed trademark *Toolprotect*.

1 Foreword

In this POWER CHAIN SAW HOLDER (also referred to as PCH) you have a state-of-the-art product as regards safety for the operators and operating safety. However, the POWER CHAIN SAW HOLDER may be a source of danger, if it is used or assembled by insufficiently trained personnel, incorrectly used or used other than for its intended use. We draw attention to potential hazards in Chapter 3, "Safety of the POWER CHAIN SAW HOLDER" and by means of safety notices throughout the documentation.

The present documentation shows how to work safely on and with the POWER CHAIN SAW HOLDER. It contains safety notices which must be obeyed without fail!

All persons who work on and with the POWER CHAIN SAW HOLDER must have the documentation available during their work and must comply with the information and notices relevant to them. The documentation must always be complete and totally legible.

1.1 Marking

The POWER CHAIN SAW HOLDER is fitted with a type plate.

As a safety component, the POWER CHAIN SAW HOLDER comes under Directive 2006/42/EC (Machinery Directive) and therefore bears the CE mark.

1.2 Legal Notice

Cepak GmbH

Schützenberg 3
3970 Weitra, Austria

Telephone: 0043 - 2856-22899
Mobile: 0043 - 664 16 12 579

E-mail: office@toolprotect.at
Website: www.toolprotect.at

1.3 Liability

The manufacturer accepts no liability for loss which arises from:

- use of the POWER CHAIN SAW HOLDER other than for the intended use;
- disregard of instructions in this Assembly and Operating Guide;
- unauthorised modifications to the POWER CHAIN SAW HOLDER;
- inappropriate work on and with the POWER CHAIN SAW HOLDER;
- insufficient inspection of components of the POWER CHAIN SAW HOLDER which are subject to wear and tear;
- improperly performed repairs;
- disasters, effects of foreign bodies and force majeure;
- non-compliance with national laws and/or standards (country of use).
- The POWER CHAIN SAW HOLDER has been designed **solely for use in the European Union (EU, EEC, CE, CEE, EC)** and may not be marketed, re-sold or used in third-party countries.

2 Intended Use

This POWER CHAIN SAW HOLDER, manufactured from elastic technical plastic is intended to protect man and machine and ensure safe handling of hand-operated power saws in use, during transport and during work breaks. It stores the chain saw casing, the chain guide bar and the saw chain safely and at the same time prevents risks of injury from the saw chain. The specifications in the operating guide for the respective POWER CHAIN SAW must be read, understood and complied with absolutely.

This special power chain saw holder with the integral load securing belt also provides extra load securing for the power chain saw.

This POWER CHAIN SAW HOLDER has therefore been designed primarily for use on selected commercial, municipal and agricultural vehicles, extensions and working equipment, as well as for special vehicle construction, where high safety standards for the power chain saw operator is required, together with high availability of the power chain saw as a work tool.

Before mounting the saw holder on vehicle or extension devices, the vehicle supplier or importer must always be consulted as to the suitability of the PCH for mounting on the vehicle or trailer. Prior clarification is mandatory in particular in the case of emergency fire service vehicles or for disaster management etc. as to whether mounting the POWER CHAIN SAW HOLDER is permitted on the respective vehicle.

Private and commercial operators, proprietors and machine operators are responsible for complying with the national laws and/or standards in installation and operation. (For example, they must ask themselves: Am I permitted to mount the power chain saw holder on my vehicle?) In particular, you must comply with your country-specific regulations for subsequent additions to vehicles or extension devices and in case of doubt contact your competent licensing authority prior to purchase and installation.

In consequence of its intended use the POWER CHAIN SAW HOLDER is a wearing part, since during operation, due to its protective function, it is constantly in contact with the razor-sharp chain links of the saw chain. At the first sign of obvious impairment in function, such as cracks, cuts, embrittlement of materials or other indications the PCH must be taken out of service.

The POWER CHAIN SAW HOLDER must be freely ventilated at all times and must not be kept covered. It must not be packaged, covered, wrapped in plastic bags, placed or shrink-wrapped in foil bags or prevented in any other way from being freely ventilated in a natural atmosphere. This can lead to material damage, which in turn may result in loss of the protective function.

2.1 Installation Options

There are the following installation options for the POWER CHAIN SAW HOLDER:

- **Use primarily for the protection of persons** and of the power chain saw itself, during transport and in work breaks
- It is specifically forbidden to wear these power chain saw holders on the human body
- Mounting in or on a vehicle / vehicle attachment; in each case the operator must comply with the legal framework conditions in force
- Mounting in or on trailers
- Installation in or on a building
- Mounting on stands (presentation stands, work tools, such as for wood-carving)

The POWER CHAIN SAW HOLDER may be used solely for the transport, storage and protection of hand-operated power chain saws with their characteristic saw chains; for example, it must not be used to transport circular saw blades.

The POWER CHAIN SAW HOLDER may be used and installed only by authorised persons. Authorised persons are persons who are at least 18 years of age, have read and understood the Operating and Maintenance Guide for the POWER CHAIN SAW HOLDER and who have also read and understood the operating and maintenance guide for the respective power saw. Modifications to the POWER CHAIN SAW HOLDER (e.g. milling out parts in order to save weight, extension of the tool holders, etc.) are strictly prohibited.

Furthermore, if the equipment is used other than for the intended use, all liability is disclaimed and warranty claims are excluded. The POWER CHAIN SAW HOLDER may be used only under the operating conditions specified in these Operating and Installation Instructions.

2.2 Target Group and Prior Knowledge

These Operating and Installation Instructions are intended for persons who perform installation, operating and maintenance activities on the POWER CHAIN SAW HOLDER. These persons must satisfy the following prior conditions:

- This Operating and Maintenance Guide must have been read and understood.
- POWER CHAIN SAW HOLDERS are not designed to be operated by persons (including children) with limited physical, sensory or mental capacities or who lack experience and/or knowledge, unless they are supervised by a person responsible for their safety or have received from that person instructions on how to use the device.
- POWER CHAIN SAW HOLDERS must be kept out of the reach of children. Children must be supervised to ensure that they do not play with the device.
- The POWER CHAIN SAW HOLDER must not be operated by persons under the influence of alcohol, medication or narcotic drugs.

2.3 Content and Purpose of This Documentation

This Operating and Maintenance Guide contains information relevant for installing, commissioning, operating, maintaining and disposing of the POWER CHAIN SAW HOLDER.

This documentation is intended to enable persons to work with the POWER CHAIN SAW HOLDER without danger. Compliance with the advice given in this document serves to avoid risks and to prevent damage to the POWER CHAIN SAW HOLDER.

2.4 Limits of Use

Use of the POWER CHAIN SAW HOLDER is restricted as follows:

- Ambient temperature: -20 °C to +40 °C
- Relative air humidity for extended periods: 20% to 60%

Note: The elasticity of the materials reduces at temperatures below 0 °C.

In this case the part becomes more rigid. However, this effect is reversible and has no impact on the quality of the material or the useful life.



NOTICE!

Operating the PCH at constantly high outdoor temperatures in conditions of high air humidity may, due to the materials used in its construction, lead to a reduction in its useful life. In this case the regular inspections of the POWER CHAIN SAW HOLDER for evidence of material fatigue, such as cracks, embrittlement of materials or similar signs must be conducted more frequently and with particular care.

Therefore, the POWER CHAIN SAW HOLDER must be freely ventilated at all times and must not be kept covered. It must not be packaged, covered, wrapped in plastic bags, placed or shrink-wrapped in foil bags or prevented in any other way from being freely ventilated in a natural atmosphere. This can lead to material damage, which in turn may result in personal injury and, where applicable, additional damage to property. **Care must be taken on this point in particular where the equipment is stored for a relatively long period, especially however in the event of shipment and the corresponding transport packaging required.**

2.5 Period of Use

The POWER CHAIN SAW HOLDER must be taken out of service if there is any obvious sign of damage, embrittlement of materials or other identifiable signs of ageing of the plastic.

3 Safety of the POWER CHAIN SAW HOLDER

This documentation is organised in accordance with the EU regulations in force and contains safety notices. The individual persons are themselves responsible for complying with the safety notices.

This chapter contains a general introduction to the safety notices, together with the description of the warning and safety notices on the safety markings in accordance with 2006/42/EC on the POWER CHAIN SAW HOLDER. In it you will also find important accident prevention notices.

3.1 Signal Words Used in Safety Notices



DANGER!

A safety notice with the signal word **DANGER** indicates an **immediate threat of danger** to the life and health of persons!

Immediate threat of danger to life



WARNING!

A safety notice with the signal word **WARNING** indicates a **dangerous situation**, which may have consequences for the health of persons!

Risk of personal injury (serious injury) and potential additional damage to property



CAUTION!

A safety notice with the signal word **CAUTION** indicates a **potentially hazardous situation**, which may in particular cause damage to property!

Risk of damage to property and potential additional danger of minor injury

3.2 Symbols Used in Safety Notices



WARNING!

This safety notice indicates a **potentially dangerous risk of crushing!**
Risk of personal injury and potential additional damage to property.



DANGER!

This safety notice indicates a **potential hazard from caustic substances!**
Risk of personal injury and potential additional damage to property.



CAUTION!

This safety notice indicates a **potential explosion hazard!**
Risk of personal injury and potential additional damage to property.



WARNING!

This safety notice indicates a **potential cutting hazard!**
Risk of personal injury and potential additional damage to property.



WARNING!

This safety notice indicates a **potential fire hazard!**
Risk of personal injury and potential additional damage to property.



IMPORTANT!

Notice of the duty to read the documentation!
Non-compliance with these notices may lead to reckless behaviour by the personnel.



NOTICE!

Notice of addition information and/or of cross-references!

3.3 Residual Hazards

Even with the maximum of care in the design and construction of the POWER CHAIN SAW HOLDER and taking into account all the safety-related situations, residual hazards may remain, which have been assessed by means of a risk assessment.



WARNING!

The PCH must always be secured by all four screw fixings in the basic assembly kit provided. All the screw fixings specified in the specification, including the corresponding washers must be used in the sequence and position illustrated. Only the original screws, the original extra large body washers and the original self-locking lock nuts from the basic assembly kit must be used.



WARNING!

When seen from in front, the PCH must be mounted at an angle of 0° to 45° to the vertical. In the case of installation on mobile objects, such as vehicles, accessory equipment, etc. the front end of the chain saw guide bar must always point in the main direction of travel. See the sketches in section "Installation / Place of Assembly".



WARNING!

The screws must be checked daily for tight fit and possible damage and tightened up if necessary or replaced by equivalent new parts. Before replacing parts take note of the standards and strength classes for these components listed in the scope of delivery.



WARNING!

When using weld-on screw adapters (optional accessories) the welding must be performed by an authorised specialist workshop. The load bearing capacity of the mounting structure must in every case be agreed with the vehicle or equipment manufacturer. The welded joints and the mounting plate must be checked regularly for cracks and damage.



WARNING!

While in place on the PCH the power chain saw must never be filled with fuels such as petrol-oil mixtures, Aspen, chain saw oil, etc. The power chain saw must be removed from the PCH before being fuelled. In the case of electrically-driven power chain saws, e.g. those driven by accumulators, the power chain saw must not remain in the PCH during the charging process.



DANGER!

The PCH must be secured with the original safety belt specified as the transport securing device, so that the power chain saw can be secured in the PCH by means of a stable component. This is usually the upper mounting bracket; on no account must it be secured by the chain brake lever.



DANGER!

The PCH must not be worn on or secured to the human body or pack animals. It is completely unsuitable for this and failure to comply with this instruction will incur the most extreme danger to life and limb!



DANGER!

It is forbidden to transport a power chain saw by means of the PCH without first securing the power chain saw with the safety belt provided and already attached!



WARNING!

The power chain saw may be secured in the PCH only with the belt provided. It is forbidden to modify the safety belt, which has been supplied.



WARNING!

Use the PCH exclusively for power chain saws of a compatible size. A table of dimensions and weights is provided in Section 4. Otherwise the protective function cannot be guaranteed.



WARNING!

Before transporting a power chain saw by means of the PCH, the saw must always be completely inserted into the PCH and secured by means of the safety belt.



WARNING!

It is absolutely essential that the power chain saw is switched off before it is inserted into the PCH.

It is strictly forbidden to insert a power chain saw into the PCH while the motor is running or to start the motor when the saw has been inserted into the PCH.

Electric power chain saws must always be disconnected from the power supply (power cable unplugged) before the PCH is used.

**WARNING!**

Never insert the power chain saw into the PCH while the motor is running! Allow the motor, the blade, the saw chain and in particular the exhaust, to cool sufficiently before installing the device in the PCH.

The PCH must be installed in a way which ensures that there is no danger of any external source of heat (such as, for example proximity to an exhaust, engine, cooler, hydraulic pump, air compressor of a tractor, etc.) igniting the power chain saw or the PCH.

**WARNING!**

The PCH must be regularly cleaned to remove any contamination, in particular flammable residues such as chain saw oils, petrol mixtures, Aspen, wood shavings, tree resin, leaves, etc.

**WARNING!**

The wearing of protective gloves by the operator is compulsory.

**DANGER!**

The PCH, including the power chain saw inserted into it, must be mounted on vehicles or trailers only in a way which complies with the respective country-specific vehicle laws or equivalent regulations (e.g. no projecting parts = must not extend beyond the vehicle contour).

**CAUTION!**

The PCH must be mounted so that the power chain saw inserted into the PCH does not obstruct the view of the driver of the vehicle/ tractor.

**WARNING!**

The PCH, including the mounted power saw, must never obscure the vehicle's signal lights, position lights, warning lights, displays, lights, indicators, etc. in such a way that these cannot be seen by other persons.

**WARNING!**

The PCH must be installed with an upward safety distance from the ground and at the sides so that when the vehicle drives over a hill or through a hollow, the PCH cannot touch the ground or any overhead components, such as bridges, ceilings, gates or similar; this can put persons, buildings and material at risk.



WARNING!

The PCH must be mounted on vehicles / trailers so that, once inserted into the PCH, the power saw does not project beyond the vehicle contour.



WARNING!

The power chain saw must always be stored nose-down in the PCH. This means that the self-weight of the power chain saw, impelled by gravitational force, pushes the saw into the PCH.



WARNING!

It is forbidden to carry out any maintenance work whatsoever on the power chain saw while it is stored in the PCH.



WARNING!

The PCH must never be installed in work areas in such a way that persons may be caught up in it and an injury or falling hazard is created. This hazard can arise e.g. specifically in the area of work platforms and also in conjunction with life lines (such as e.g. PPE = personal protective equipment).



WARNING!

The PCH must not be installed in the area of moving parts on other machinery, in particular cable control elements of e.g. cable winches (dead man's handle!), in order not to restrict their freedom of movement and function.



WARNING!

It is forbidden to mount the PCH within the swivel range of trailer draw-bars, if this may restrict their room for manoeuvre, fails to comply with safety distances or may cause other hazards!



WARNING!

It is forbidden to mount the PCH within the stroke range of hydraulic components if this may restrict their room for manoeuvre, fails to comply with safety distances or may cause other hazards!



WARNING!

The PCH must be inspected daily prior to starting work for signs of wear and tear, such as cracks, cuts, holes, embrittlement, signs of ageing specific to plastic and if necessary the part must be replaced immediately.

**WARNING!**

The mounting surface must be sufficiently stable. Detailed information on this can be obtained from your vehicle supplier or importer, from authorised specialist workshops or vehicle registration offices.

**WARNING!**

The power chain saw holder must as a matter of principle be mounted vertically. It is forbidden to mount the PCH so that it projects.

**NOTICE**

Operators of the PCH must read the Assembly and Operating Guide.

**NOTICE**

When the POWER CHAIN SAW HOLDER finally becomes unserviceable dispose of the parts by an environmentally-sound method and unmixed (metal as appropriate scrap metal, old oils and liquids in accordance with the statutory regulations)!

3.4 Safety Notices for the Operator



IMPORTANT!

Ensure that each person who works on the POWER CHAIN SAW HOLDER for the first time has read and understood this documentation. Take particular care to comply with the safety notices in this documentation and on the POWER CHAIN SAW HOLDER. Keep the documentation in the vicinity of the POWER CHAIN SAW HOLDER and pass the documentation on to new operating personnel. Ensure that no-one works on the POWER CHAIN SAW HOLDER without expert knowledge.



WARNING!

Ensure that the notices attached to the POWER CHAIN SAW HOLDER at the time of delivery remain totally legible. Missing and damaged warning signs must be replaced immediately.



CAUTION!

Use only original replacement parts. Otherwise the conditions of warranty and product liability risk may be affected. In the case of ambiguity contact the manufacturer.



DANGER!

The subsequent attachment of additional devices from third-party manufacturers and the modification of safety devices is not permitted without the agreement of Ing. Christoph CEPAK or the manufacturer of the respective additional device!

3.5 Personal Protective Equipment

The POWER CHAIN SAW HOLDER has been designed so that persons working on the POWER CHAIN SAW HOLDER require no additional protective equipment other than the standard equipment for working with a power chain saw (e.g. work-wear, safety shoes, safety helmet, protective gloves, safety glasses, ear protectors, etc.).



CAUTION!

Persons who carry out cleaning and maintenance work must comply with the regulatory precautions for the respective cleaning agents (e.g. wear gloves when cleaning, eye protection, ear protection)!

3.6 Safety Notices on the POWER CHAIN SAW HOLDER

Safety notices are attached to the POWER CHAIN SAW HOLDER, which alert personnel to potential hazards / residual hazards. The instructions on the safety markings on the POWER CHAIN SAW HOLDER must be complied with in all circumstances. At regular intervals, the notices must be checked for legibility and completeness.

From the moment when the safety notices on the PCH are no longer identifiable and comprehensible at the first glance, the POWER CHAIN SAW HOLDER must immediately be taken out of service.

The pictograms for warnings, prohibitions, and instructions on the POWER CHAIN SAW HOLDER and their meaning:

Pictograms	Description
	Notice to read the Operating Guide

3.7 General Safety Regulations and Duties

The following safety regulations and duties apply generally to handling the POWER CHAIN SAW HOLDER:

- The POWER CHAIN SAW HOLDER must not be used unless it is in a faultless, clean condition.
- It is forbidden to convert or modify the POWER CHAIN SAW HOLDER.
- Malfunctioning or damaged parts must immediately be replaced with original parts.
- Only original replacement parts may be used for repairs.
- The safety and operating notices in the documentation for the components used must be taken into account in every case.
- The area around the POWER CHAIN SAW HOLDER must be kept clean and clear of contamination. All objects and containers not required for operating the saw must be removed from the area of the POWER CHAIN SAW HOLDER.

4 Type Overview

Type	P1	P2	P3
Article Number	In planning stage	160xxx	In planning stage
Blade length BL min./max.		30/50 cm	
Blade width BW max.		10 cm	
Weight of chain saw max.		7 kg	
Length L mm		510	
Width W mm		175	
Height H mm		80	
Weight (empty, excl. mounting material)		approx. 2.8 kg	
Fixing screws		M8-8.8 (4x)	
Washers		8.4x40x2mm (8x)	
Locking nuts		M8-8.8 (4x)	
Mounting surface required min.		approx. 14x14 cm	
Load securing belt		yes	

4.1 Type Plate (on the component back, mounting surface)

List of contact data, date of production MONTH/YEAR, CE conformity and recycling code.

www.toolprotect.at office@toolprotect.at





Prod.	1	2	3	4	5	6	7	8	9	10	11	12
2016					•	•	•	•	•	•		
2017												
2018												
2019												
2020												

5 Scope of Delivery

- 1 x power chain saw holder (PCH), including installed load securing belt ①
- 1 x basic assembly kit as follows ②:
 - 4 x hex socket screw 8x45mm, strength class 8.8, DIN 933, electro-galvanized
 - 8 x screw 8.4x40x2, DIN 522, electro-galvanized
 - 4 x lock nut, self-locking, M8, strength class 8, DIN 985, electro-galvanized
- 1 x Assembly and Operating Guide (without illustration, see this print edition)
- 1 x EC Conformity Declaration (without illustration, see Appendix)
- 1 x drilling jig for the mounting quadrant of 82 x 82 mm (without illustration)

Optional

- 1 x wrench for easy assembly and disassembly. In the case of inspection of any possible duty to register the holder in the vehicle documentation the wrench, which can be purchased if required, must be kept permanently with the vehicle tool kit.



6 Installation / Place of Assembly

This POWER CHAIN SAW HOLDER has been designed primarily for use **on selected commercial, municipal and agricultural vehicles, extensions and working equipment, as well as for special vehicle construction**, where high safety standards for the power chain saw operator are required, together with high availability of the power chain saw as a work tool.

Before mounting (ideally, even before purchasing) this power chain saw holder on vehicles or trailers, the vehicle supplier or importer must always be consulted.

Prior clarification is mandatory in particular in the case of emergency fire service vehicles or for disaster management as to whether mounting the POWER CHAIN SAW HOLDER is permitted on your vehicle.

In particular you must comply with your country-specific regulations for subsequent additions to vehicles and in case of doubt contact your competent licensing authority prior to purchase and installation.

On no account must this holder be worn on the human body. Mounting it on cars, lorries (HGV) or other two or four-wheeled vehicles on the public highways is not permitted. Exceptions may be made for individual authorisations and type testing on specialist vehicles. For further information on this please contact your local licensing authority and your vehicle supplier or importer.

Therefore, the following are some of the installation options for the POWER CHAIN SAW HOLDER:

- mounting in or on a vehicle / vehicle attachment (for protection during transport of the power saw)
- mounting in or on trailers
- installation in or on a building (for protection during storage)
- mounting on stands (presentation stands, work tools, such as for wood-carving)
- use for protection during transport and in work breaks

The holder must be mounted on an **even, flat surface**, using all the screws, washers and nuts provided.

The mounting surface must provide sufficient stability and load capacity to support the PCH and the fuelled, ready-to-operate power saw, which has been inserted into the PCH. In addition, the drilled holes required must not affect in any way the stability and durability of the substructure. In all cases check with the supplier of your vehicle or attachment. (This applies in the same way to the use of the optional mounting plate for securing the PCH).

During the assembly process the mounting surface must be clean, dry and free from grease.

A **maximum tightening torque of 25 Nm** per screw connection must be used for the screw connections (M8) supplied for securing the power chain saw holder.

It is best to insert the screws from inside towards the outside, in order to give the holder maximum elasticity without any risk of collision with the bolt end protrusion. Once assembly is complete, external bolt end protrusions must be correctly removed in order to eliminate the risk of injury. For this purpose, you will find a special explanatory video on our website under the heading, "Videos".

The screws can also be **inserted from outside towards the holder** as illustrated. In this case care must be taken that potential internal bolt end protrusions do not restrict the mobility of the holder. If necessary the screws must be correctly shortened.

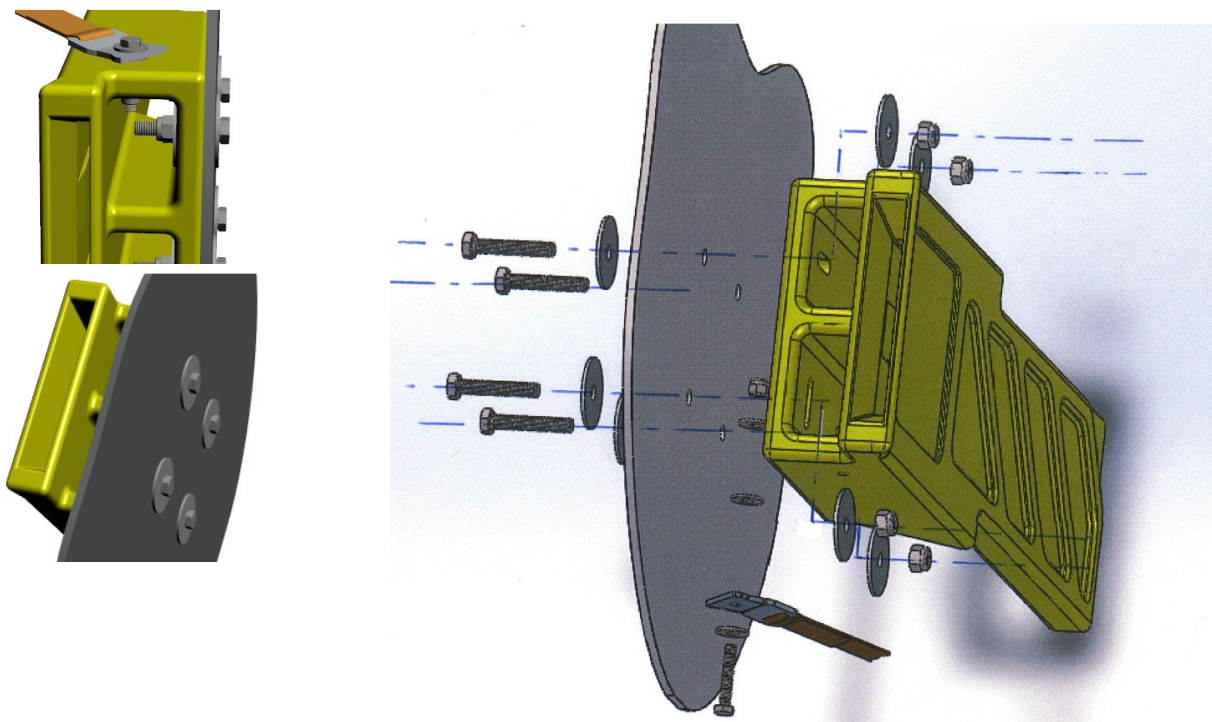

WARNING!

Assembly and mounting must be carried out exclusively by trained, authorised personnel and by means of the fixing material provided. Prior to being mounted the POWER CHAIN SAW HOLDER must always be visually inspected for possible damage.

7 Detailed Notice on Mounting and Use

- Mounting of the PCH vertically or at an angle of 45° maximum is permitted – the PCH must face towards the direction of travel.
- As a matter of principle, the holder should be mounted at a comfortable height for the operator to reach – when in any operating status, however, the PCH must not project beyond or below the vehicle – it is essential that national statutory regulations are complied with!
- As a matter of principle vertical mounting – with an angular deviation of max. +/- 10% – independent of the direction of travel.
- The power chain saw must be secured with the safety belt provided at all times during storage in the PCH.
- It is essential to comply with the following sequence of actions when inserting the power chain saw in the PCH: firstly switch off the power chain saw, then secure the chain brake, then insert the power chain saw into the holder, then attach the safety belt.
- A power chain saw (or blade, chain) which has overheated must be allowed to cool down sufficiently before being inserted into the PCH.
- The power chain saw must always be completely inserted into the PCH. The power chain saw casing must bear on the orifice of the PCH. The bumper spikes on the power chain saw must not bear on the PCH. The blade must be completely inserted and must not project from the lower end of the PCH.
- The PCH must never be covered (with or without the power chain saw).
- The PCH must be inspected daily to ensure it is correctly secured and free of faults.
- While stored in the PCH the power chain saw must not be fuelled or in the case of electrically-powered power chain saws be electrically charged. For these purposes, the power chain saw must be removed from the PCH.
- The PCH must always be kept clean. It must be cleaned with a mild, bio-degradable cleaning agent – the use of solvents is forbidden.
- Care must be taken that the PCH is not assembled in dangerous proximity to sources of heat (e.g. exhausts, engines, hydraulic aggregate).
- The PCH must be mounted so that it does not obstruct the vision of the driver or other road users in any operating status.
- The PCH must be mounted so that it does not obscure the vehicle lighting or any signal lights.
- The PCH may be secured only to permanently durable load-bearing structures. In the process also note vibrations during use.
- This PCH model has been designed and is suitable exclusively for commercially-available right-handed power saws.
- The PCH must not be mounted within the swivel area of trailers or in the mobility area of hydraulically-controlled components (due to collision risk).
- The PCH must be mounted exclusively with the basic assembly kit provided. In mounting the PCH all four screws must be used and screwed in with the maximum tightening torque.
- The power chain saw must not be started up during storage in the PCH.

8 Mounting Options

Basic assembly kit (standard)

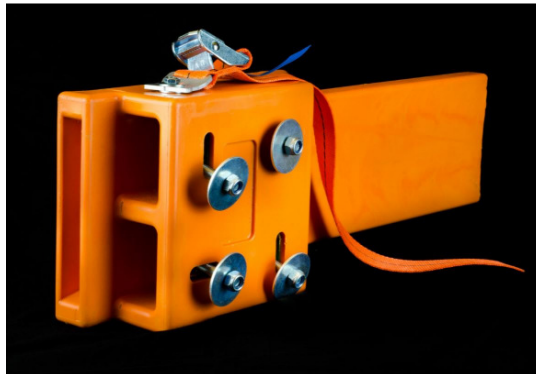

Mounting plate SHORT, weldable, screwable (optional)



Mounting plate LONG, weldable, screwable, bendable, supplied not canted (optional)

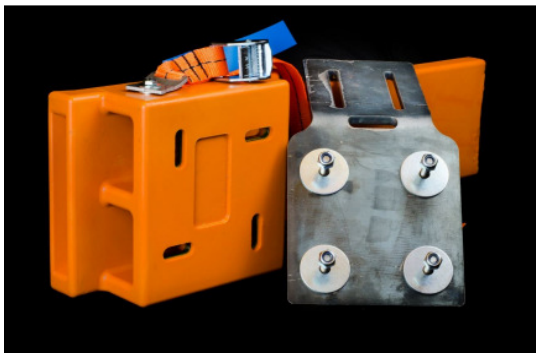

9 Initial Commissioning

The following procedure is recommended for initial commissioning. Having installed the PCH, perform all the potential movements and processes of daily routine operation with your vehicle or attachment, in the first instance without inserting a power chain saw. Activate each relevant mechanism on your equipment, such as hydraulic cylinders, doors, windows, steering, levers, etc. in each case within their maximum operational area. Repeat the test carefully using a power saw inserted and secured only when no collision points and hazards have been identified by the initial test process.

10 General Specification

This POWER CHAIN SAW HOLDER has been designed specifically for the protection of the saw chain, the blade and the power chain saw casing during transport, work breaks, storage, etc. in order to store the equipment safely, while preventing hazards to persons from the saw chain.

10.1 Structure

The following figure gives a view of the POWER CHAIN SAW HOLDER.

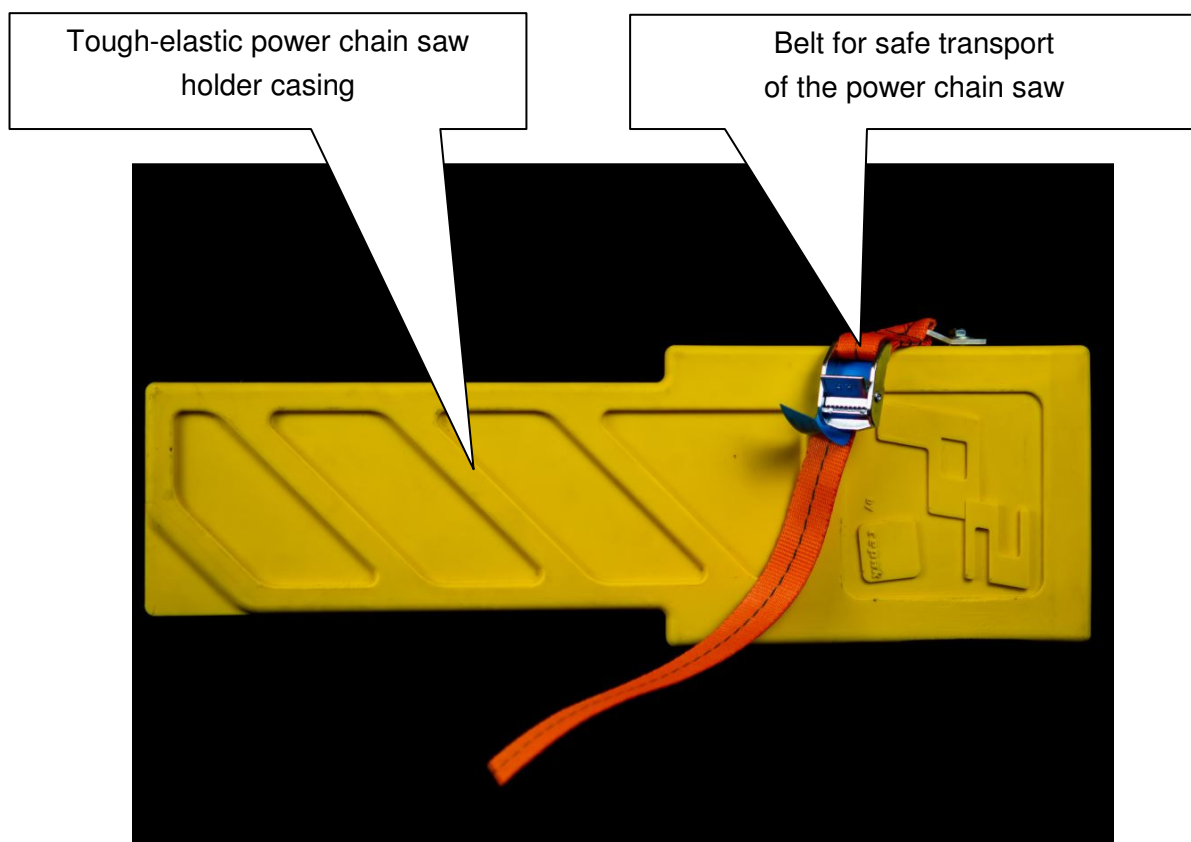

10.2 Operation

In accordance with the correct use of the PCH the unsheathed blade of the power chain saw is inserted into the wide, slit-like cavity of the POWER CHAIN SAW HOLDER to its full extent, until the casing of the power chain saw lines up with the opening of the PCH. In this process take particular care that the power chain saw does not sit with the bumper spikes at the opening of the PCH.

Next, the safety belt on the PCH is immediately locked and thus the power chain saw is secured in position. To do this, the safety belt is fed through the upper mounting bracket of the power chain saw, drawn through the fixing bracket and tensioned. The belt is tensioned by pulling towards the power chain saw handle, as shown below. The tension required depends on the design of the respective power chain saw. The belt must be tensioned solely manually.

**Pull the belt in the direction of the power chain saw,
in order to tighten this "hand-tight"!**

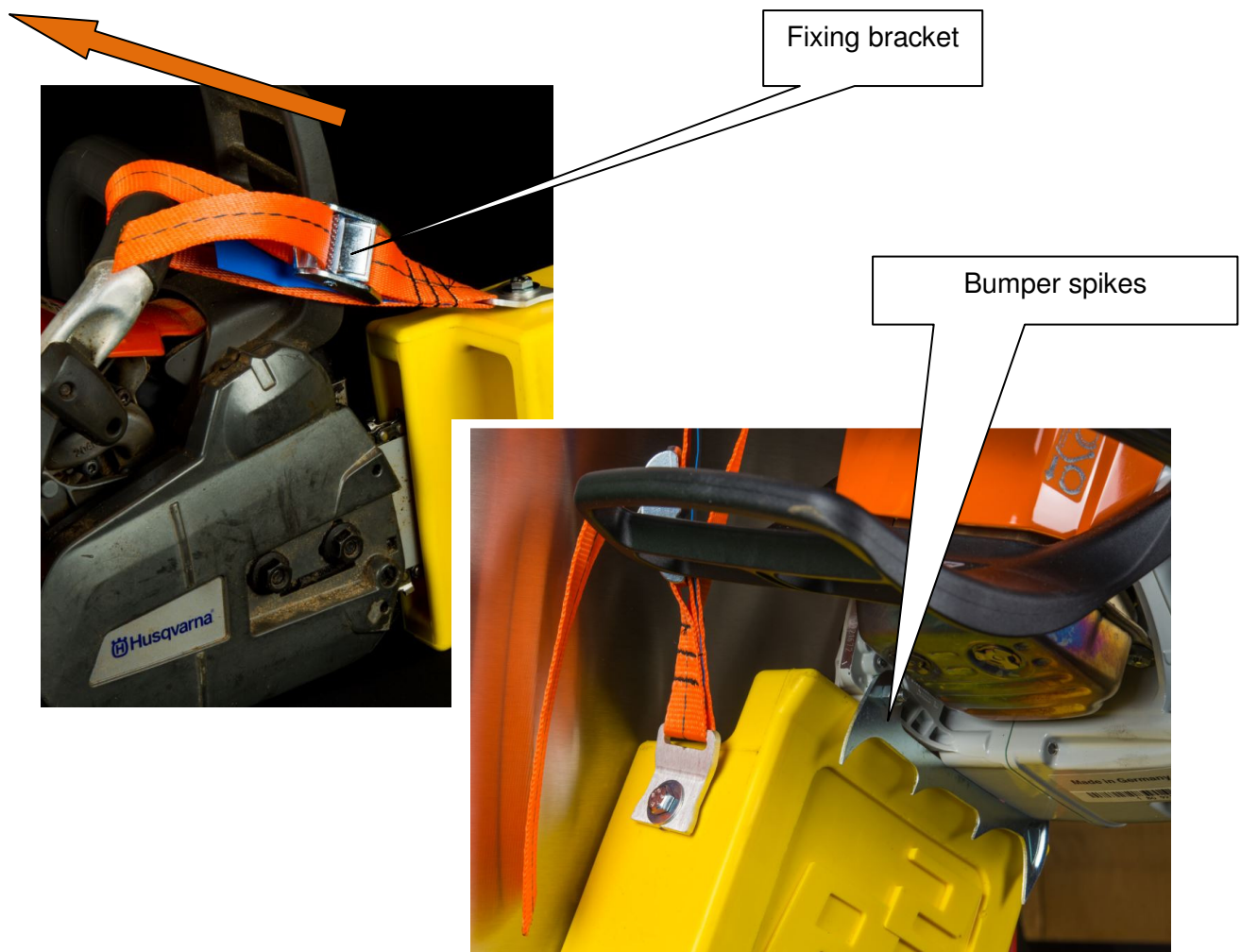

11 Servicing and Maintenance Activities

11.1 Cleaning the POWER CHAIN SAW HOLDER

The POWER CHAIN SAW HOLDER may be cleaned only by trained persons who have been informed of the potential dangers from this POWER CHAIN SAW HOLDER.

The POWER CHAIN SAW HOLDER should be briefly wiped with neutral cleaning agents and warm water, brushed off or swept and finally dried with a cloth.

The use of high-pressure cleaners, steam cleaners or submerging the holder in cleaning agent or solvent is strictly forbidden, since this may affect the material. The danger arising from this ranges from damage to the material to loss of the protective function.



DANGER!

Be alert to the risk of slipping especially in the vicinity of lubricants and waste wood (chips, sawdust) on the floor.

11.2 Maintenance

General Maintenance Tasks

Written records of routine maintenance must be kept and archived.

- **Daily** inspection of all screw fittings. If necessary, tighten all screw fittings.
- **Daily** inspection of the holder for cracks and cuts. If necessary, replace.

Due to the undersize of the holder in relation to the power chain saw blade, based on which the special clamping action of this structure results, in the early stages minute plastic chips are usually abraded. Fewer of these chips occur as a rule in the course of regular operation and due to the use of chain lubricants. Depending on the type and scope of use, wear occurs to a greater or lesser extent to the walls of the power chain saw holder; the operator must regularly and individually assess the obvious impact of this on further serviceability.

- **Daily** inspection for potentially hazardous or easily flammable residues and pollutants. If necessary, clean the PCH accordingly.
- **Daily** inspection of the load securing belt and its fixing bracket for damage. If necessary, replace the load securing belt from the relevant replacement part list.

11.3 Repair

Repairs by unauthorised persons are not permitted. No attempt must be made to glue, weld or otherwise to process the material of the PCH. A damaged PCH must be immediately replaced or withdrawn from service.

12 Replacement and Wearing Parts

Please take note of the instructions on the type plate of your PCH. Replacement parts can be found at any time on www.toolprotect.at. We will be delighted to send you on request a list of replacement parts.

- Casing power chain saw holder
- Load securing belt including fixing material
- Basic fixing material
- Assembly and Operating Guide
- EC Declaration of Conformity
- Optional: Mounting plate short / long

13 Shutting Down the POWER CHAIN SAW HOLDER

13.1 Principle



NOTICE

When the POWER CHAIN SAW HOLDER parts finally become unserviceable dispose of the parts by an environmentally-sound method and unmixed (metal as appropriate scrap metal, old oils and liquids in accordance with the statutory regulations)!

Before disposing of substances and POWER CHAIN SAW HOLDER parts, test to find out whether they can be recycled. Recycle as much as possible.

Negligent or wrongful disposal can cause unforeseen damage. Dispose of substances and POWER CHAIN SAW HOLDER parts by methods demonstrably sustainable for humans, the natural world and the environment.

For this purpose, retain the manufacturer's instructions and the relevant laws and regulations.



The casing of the POWER CHAIN SAW HOLDER (without attached and built-in parts) consists of a technical plastic. The PCH can be disposed of in household residual waste or taken to public collection points.

13.2 Materials and Parts for the Power Chain Saw Holder

The material used to manufacture the PCH is an industrial high-performance plastic. Over the course of time this material undergoes both a natural ageing process specific to plastic and a certain darkening of the intrinsic colour. Depending on the colour chosen, over a period of use this can result in a modification in the colour of the PCH. This modification in colour has no effect on the mechanical properties.

Any potential colour change or modification in colour over the period of use can therefore not be accepted as a ground for a complaint or claim.

In consequence of its intended use the POWER CHAIN SAW HOLDER is a wearing part, since during operation, due to its protective function, it is constantly in contact with the razor-sharp chain links of the saw chain. At the first sign of obvious impairment in function, such as cracks, cuts, embrittlement of materials or other indications, the holder must be immediately replaced.

14 Appendix

14.1 EC Declaration of Conformity

EC DECLARATION OF CONFORMITY

for machines (2006/42/EC)

Manufacturer: ASMA Polyurethane GmbH
Gmünder Straße 229
A-3970 Weitra

Machine: POWER CHAIN SAW HOLDER as safety component
First year of construction: 2016

It is hereby certified that the machine complies with the health and safety requirements of Machinery Directive 2006/42/EC, and that the technical documents have been submitted in accordance with Appendix VII A and the following harmonised standards have been applied:

EN ISO 12.100 General Design Principles – Risk Assessment and Risk Reduction
EN 82079 Preparation of instructions for use

Documentation Manager

Cepak GmbH

Schützenberg 3
A-3970 Weitra



Weitra, 17.08.2017

Distributor

Cepak GmbH

Schützenberg 3
A-3970 Weitra



CEO Ing. Christoph Cepak for Cepak GmbH